

パール挿入孔詳細 (S=1/10)

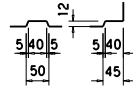

ガイドピン孔詳細 (S=1/10)

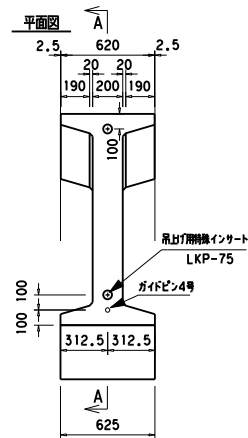
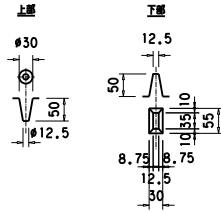

A-A 断面図

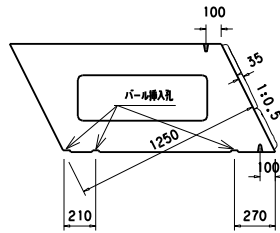

正面図

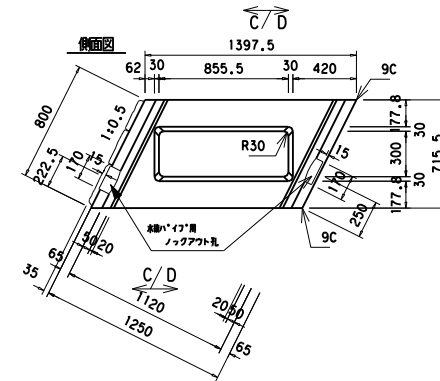
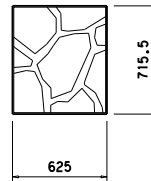

C-C 断面図

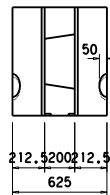

D-D 断面図

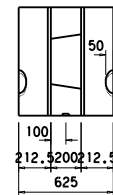

図名	KP大型ブロック 1250B (高擁壁用)		
尺度	1/50	参考重量	455 kg
小倉セメント製品工業株式会社			