

パール挿入孔詳細 (S=1/10)

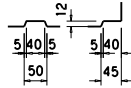

ガイドピン孔詳細 (S=1/10)

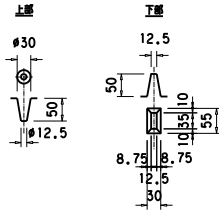

A-A 断面図

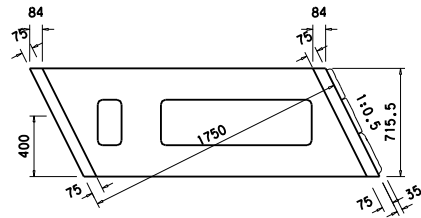

B-B 断面図

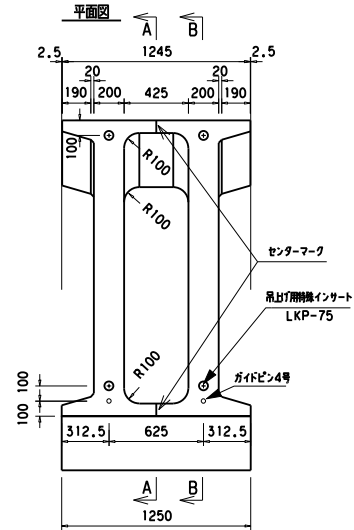
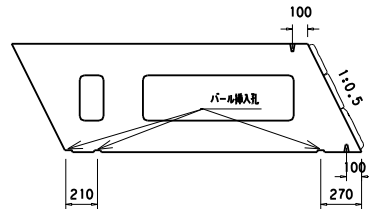

正面図

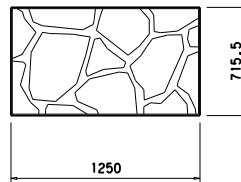

C-C 断面図

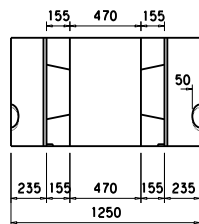

D-D 断面図

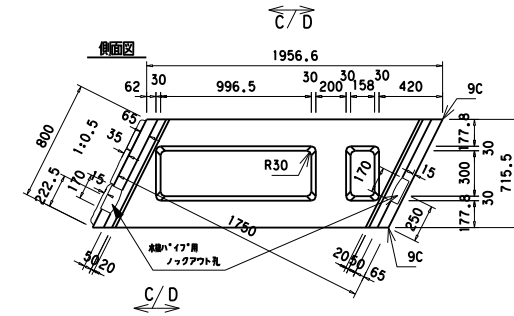
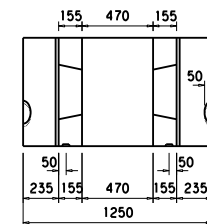

図名	KP大型ブロック 1750A (高擁壁用)		
尺度	1/50	参考重量	1150 kg
小倉セメント製品工業株式会社			